











Disney
TRON
LEGACY

21314



-  Booklet available in English on
-  Heft in deutscher Sprache erhältlich auf
-  Livret disponible en français sur
-  Libretto disponibile in italiano su
-  Folleto disponible en español en
-  Folheto disponível em português em
-  A füzet magyarul ezen a honlapon olvasható
-  Buklets latviešu valodā pieejams vietnē
-  如需中文版手册，请访问 www.LEGO.com/ideas



LEGO.com/ideas

FUTURISTIC FAN DESIGNERS



BROTHERS
DREW & TOM

Downloading from Devon, England, brothers Drew and Tom are the talented fan designers behind the LEGO® Ideas TRON: Legacy set.

“As fans of Disney’s TRON: Legacy film and avid fans of science fiction, it was the whole essence of the digital world in the movie that we really wanted to represent. This inspired us to make the iconic Light Cycle, a fundamental element of the TRON universe.”

Tom and Drew’s small childhood collection of LEGO bricks inspired them to come up with their own scenarios and builds. In designing their LEGO Ideas project, “We went through several models before settling on a design we both liked. We wanted to get the scale of the Light Cycle to LEGO Minifigure right, and the overall color scheme had to reflect the TRON feel.”

“We were very happy to achieve the milestone of 10,000 votes, and this being our first LEGO Ideas project adds to the overall joy. It was a great experience gathering support, as well as receiving great comments along the way. Creating a successful project can be hard and it can take time, so we would say not to rush things when creating a model, as you can always come back to it with new ideas and creativity.”

LIGHTSPEED LEGO® DESIGNERS

LEGO® Senior Designers Junya Suzuki and Samuel Johnson teamed up to transform Drew and Tom's idea into an official LEGO model.

“We're both big fans of the TRON movies, since seeing the first movie as kids, and it was epic!” says Junya. “One of the biggest challenges we faced during the development of the model was that the original LEGO Ideas submission was fantastic, but it was designed for stationary display. We decided to change the design slightly so it could roll smoothly, like in the movie. The final model is packed with fine detailing, smooth lines and curves, plus awesome graphics. It really recreates the Light Cycle in the perfect way for this scale.”

LEGO Graphic Designer Mark Tranter was responsible for the decoration on the finished model and characters. “I have always loved the look of the original TRON costumes, they were so iconic and retro. What I love about the new look in TRON: Legacy is that it keeps a similar retro feel, like an '80s vision of the future. The updated costumes keep the 'TRON-Lines' running over modern-looking body armor, and that was really fun to explore.”



MARK TANTER, JUNYA SUZUKI
& SAMUEL JOHNSON



Disney

TRON

L E G A C Y

Disney's TRON: Legacy is the sequel to the 1982 cult classic sci-fi movie, TRON. It follows the adventures of Sam Flynn, a brave but reckless young man who finds himself digitized into a computer world of living programs and futuristic vehicles. Equipped with an identity disc and forced to compete in the dangerous Games, he must battle and race if he hopes to survive.

But Sam won't be alone. Quorra, a mysterious woman who works with Sam's long-lost father, Kevin Flynn, rescues him. Years ago, Kevin tried to create the perfect computer system, but he was betrayed by a program called Clu. Now it is up to Sam and Quorra to prevent Clu and his warrior program Rinzler from succeeding in their plan to escape and conquer the real world.

Released in 2010, Joseph Kosinski directed TRON: Legacy for Walt Disney Pictures. It stars Garrett Hedlund as Sam Flynn, Olivia Wilde as Quorra, and Jeff Bridges as Kevin Flynn and Clu.

SAM FLYNN

Sam is the son of Kevin Flynn, the human hero of the original TRON film. He is smart, confident, adventurous and always willing to take risks. His search for his missing father leads Sam to be pulled into the digital reality of the Grid, where he is tested in a series of gladiatorial games before confronting the system's corrupt ruling program.



QUORRA

Quorra is a strong young woman and one of the Grid's greatest drivers. A digital life form that came into existence within the computer system itself, she was rescued in the Outlands by Kevin Flynn and now acts as his trusted apprentice. Her mentor's stories about the real world beyond her virtual reality have filled Quorra with a desire to experience it for herself.



RINZLER

The silent, masked Rinzler is the loyal henchman and enforcer to Clu, the corrupt ruler of the Grid. He waits by his master's side until given commands, which he carries out without hesitation or doubt. The most skilled fighter in the system, he is also the only program who makes use of 2 identity discs. Originally known as TRON, Rinzler's identity came into being when TRON was "repurposed" by Clu.



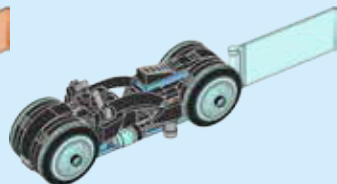
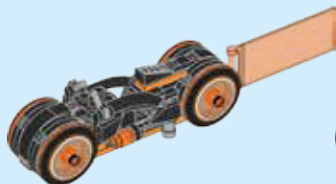
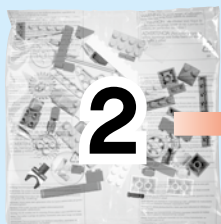
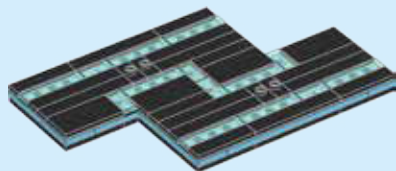

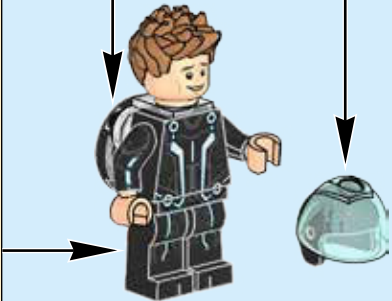
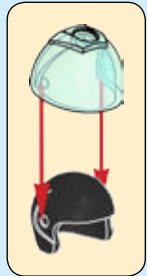
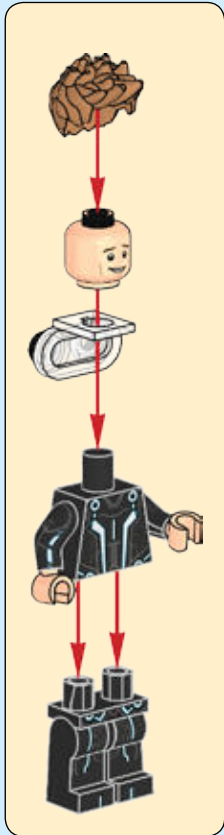
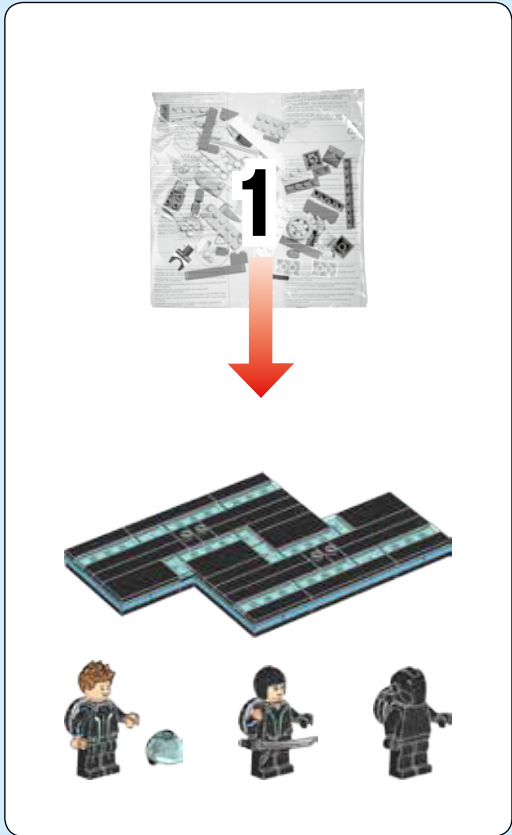

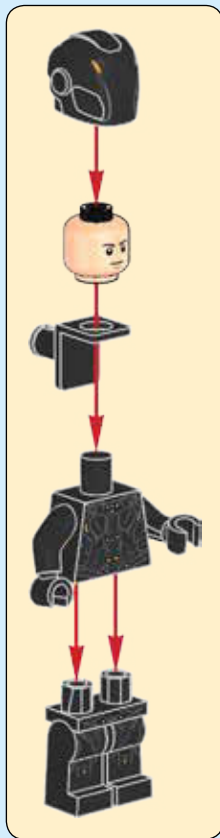

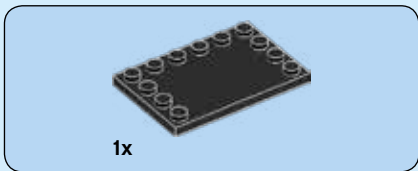
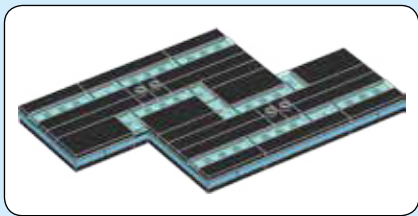

1

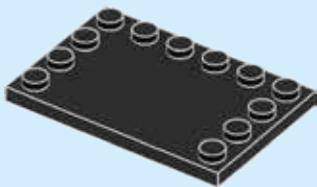

2

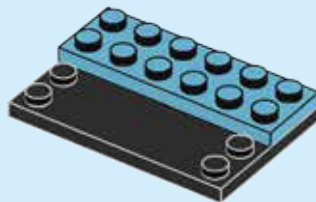

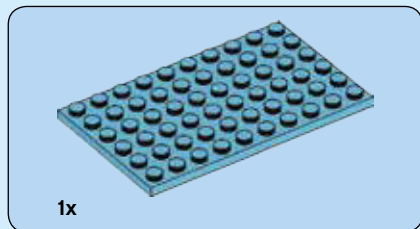

3

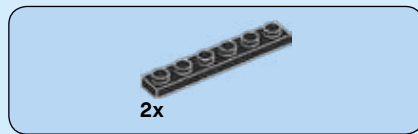
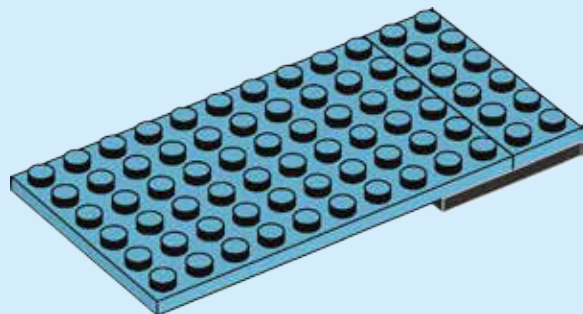

4

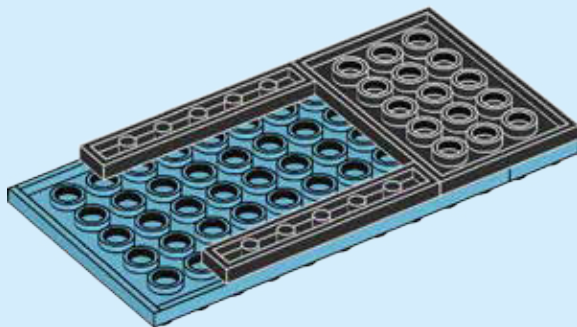
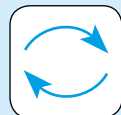

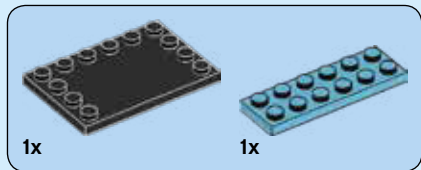

5

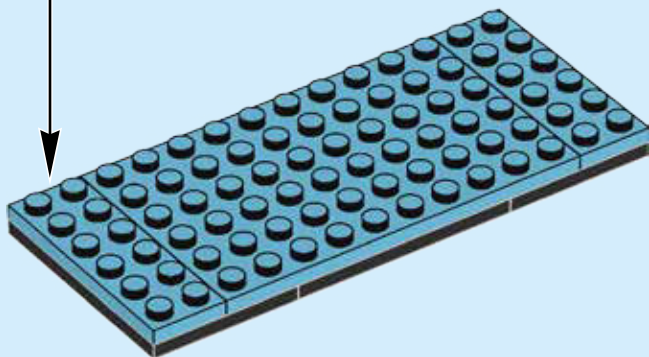
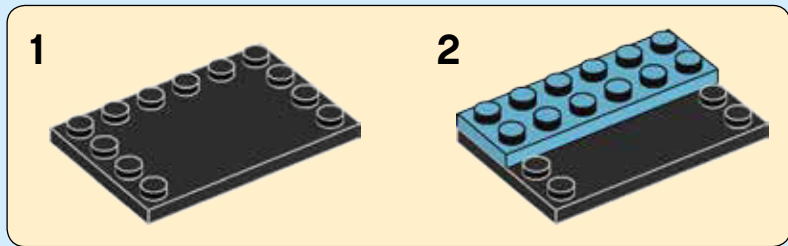
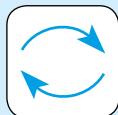

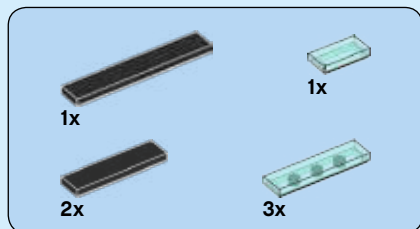

6

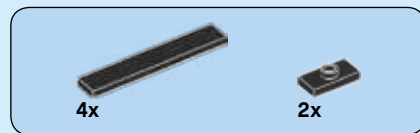
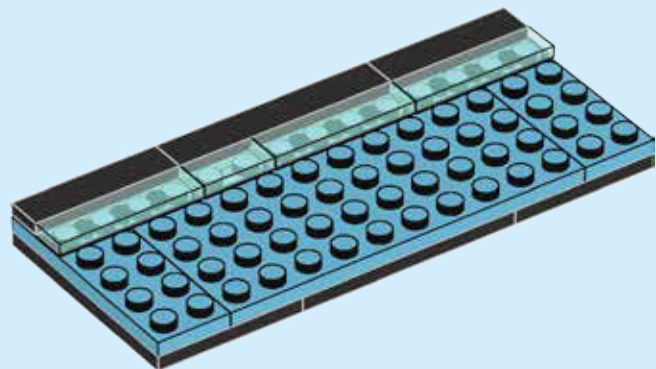

7

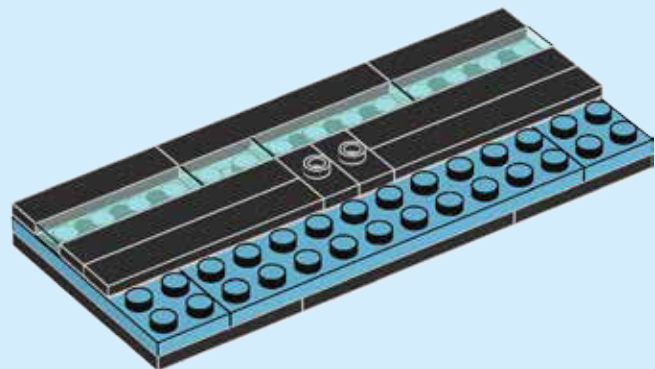

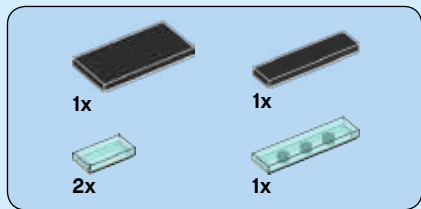

8

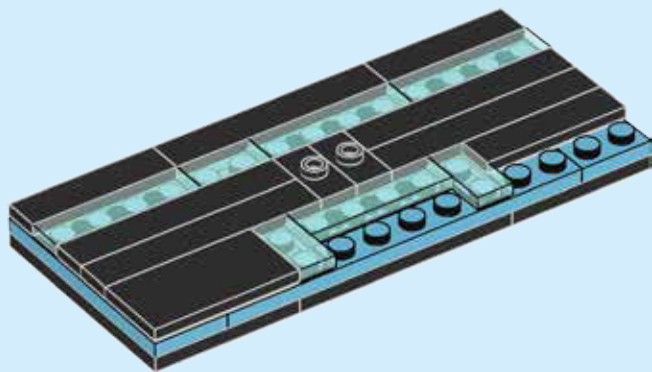

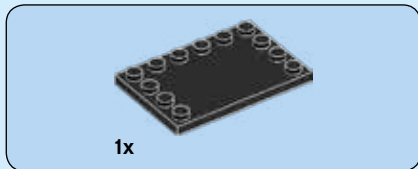
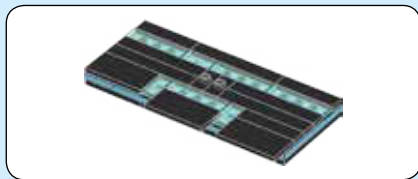

9

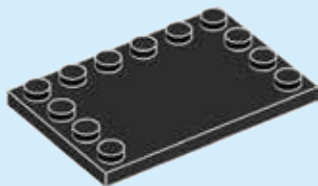

10

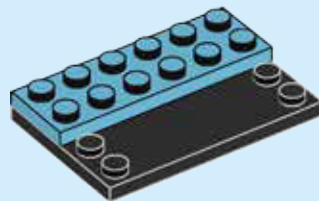

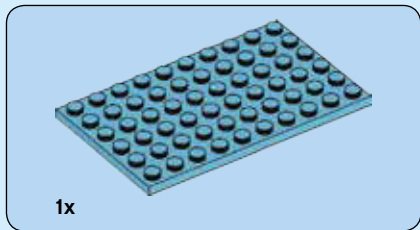

11

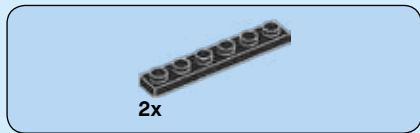
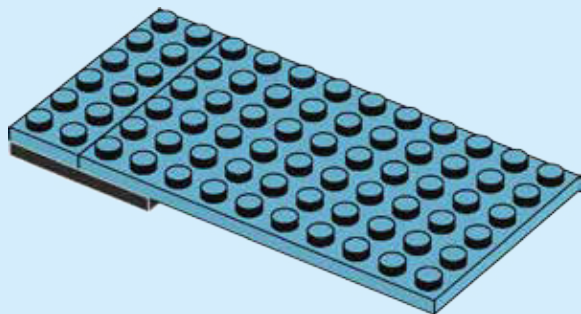

12

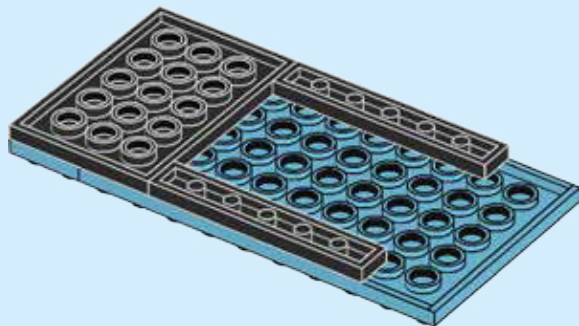
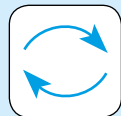

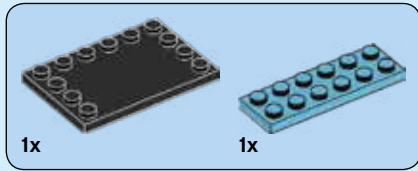

13

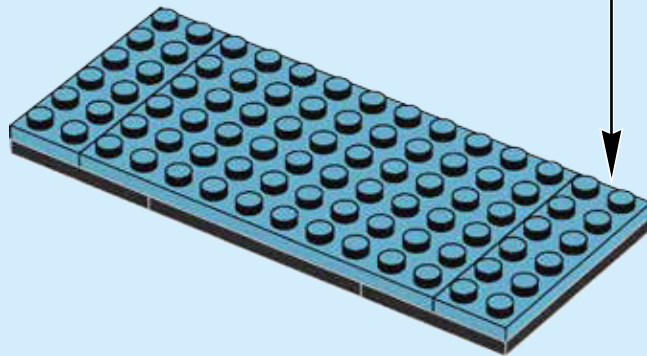
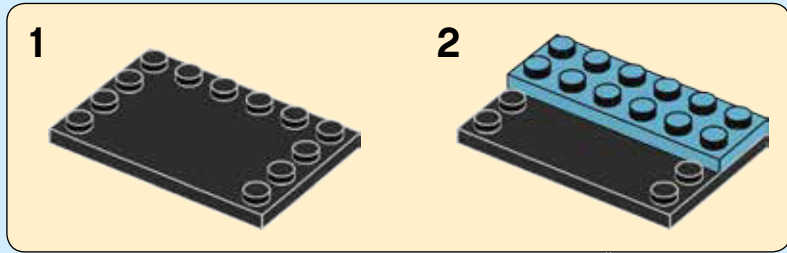
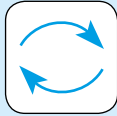

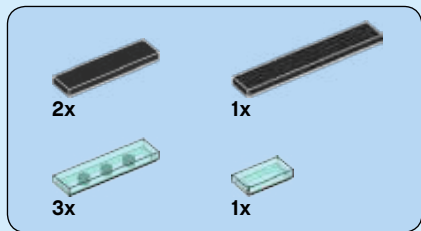

14

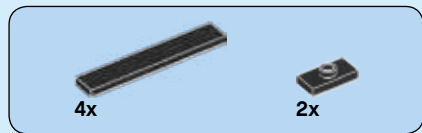
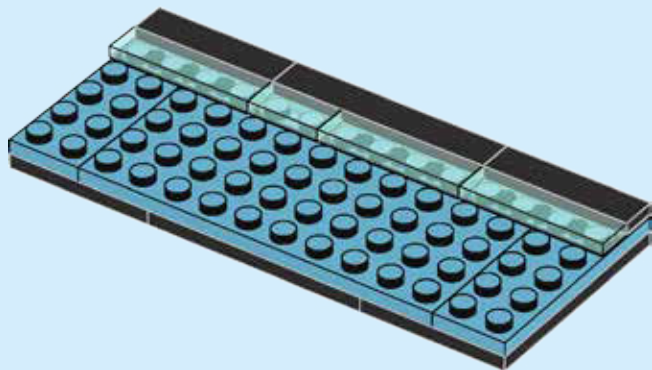

15

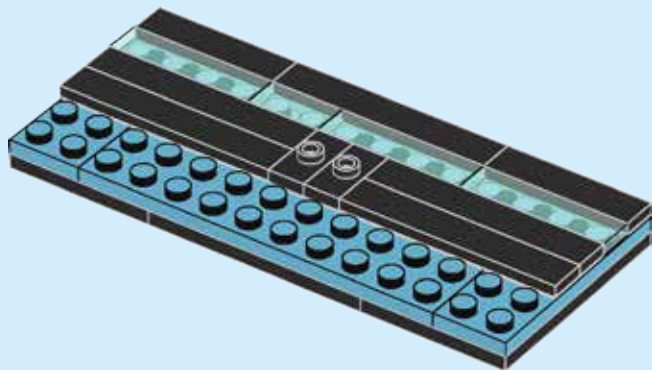

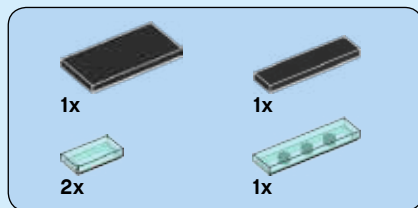

16

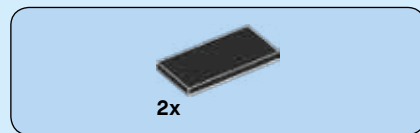
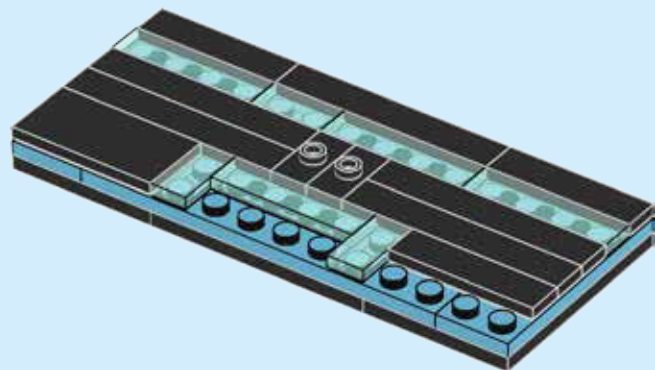

17

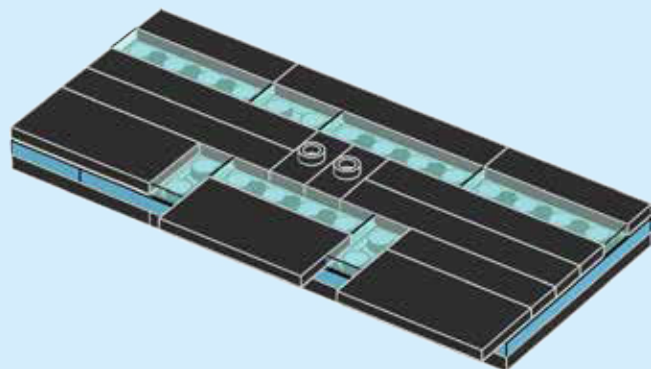

18

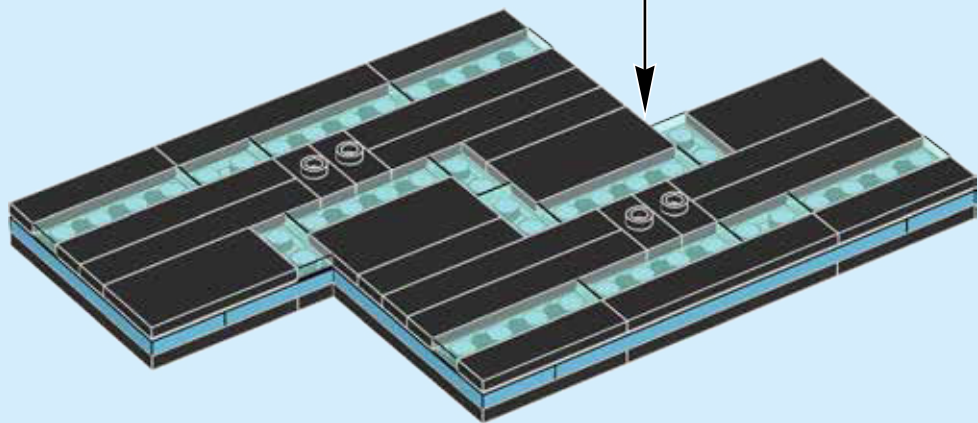

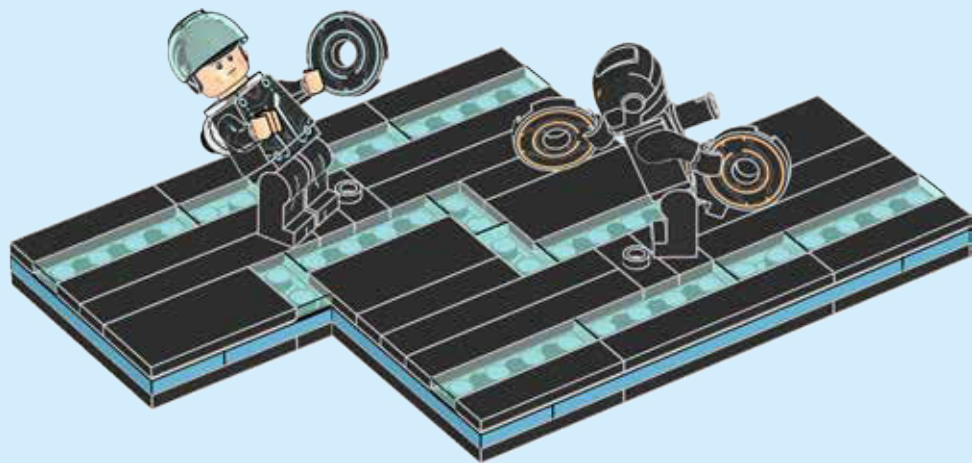

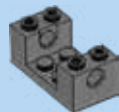
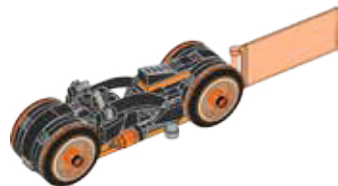
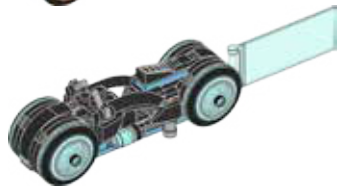
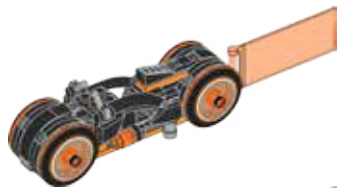
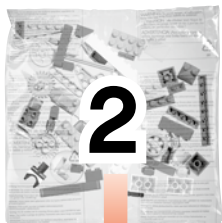

1x

1

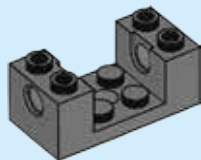



2x

2

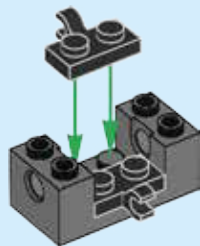

2x

3

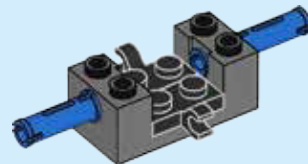



1x



2x

4

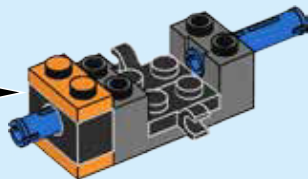
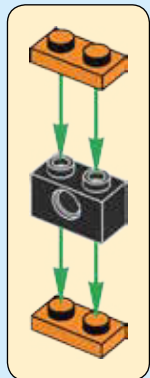

24



1x

5

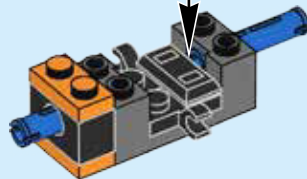



2x

6

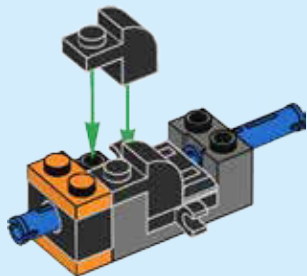

2x



2x

7

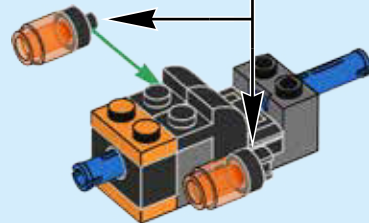
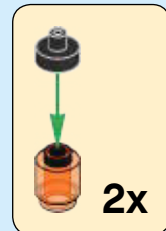



2x

8

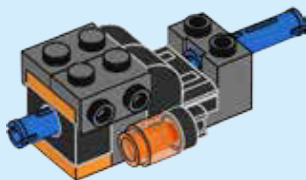

1x



1x

9

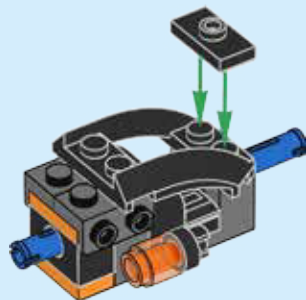



10

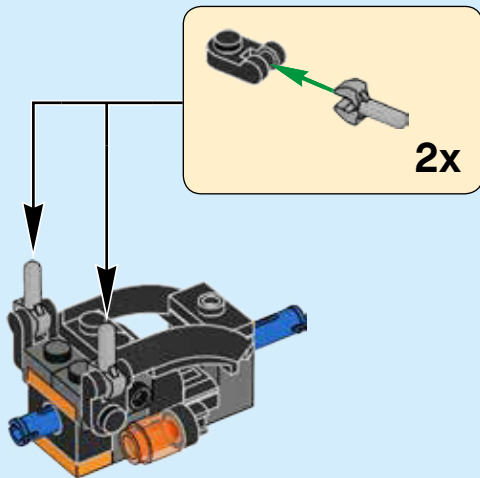

11

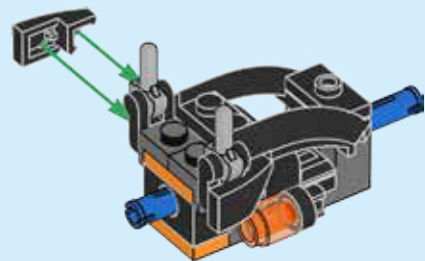



1x



1x

12

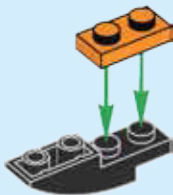

1x

13





1x



1x

14



1x



1x

15

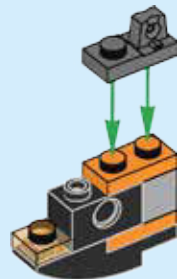

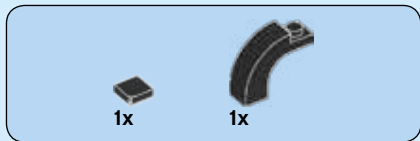

16

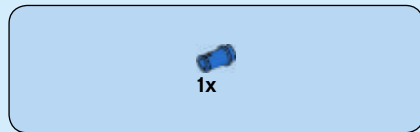
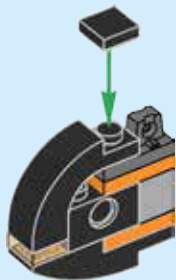

17

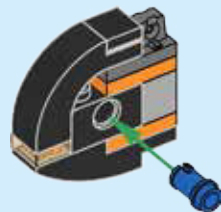

18

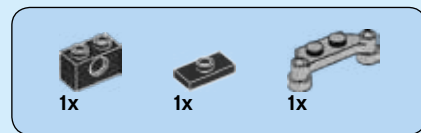
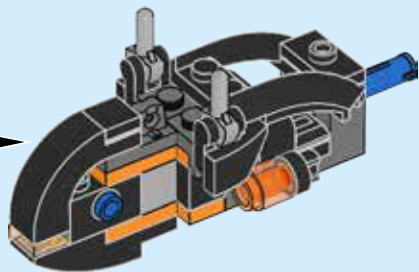

19

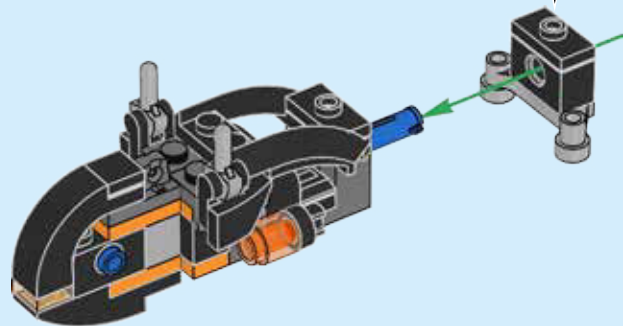
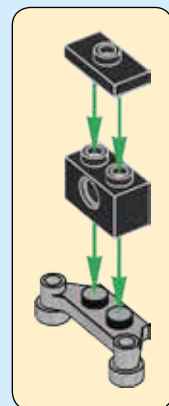



20



21





1x



1x

22

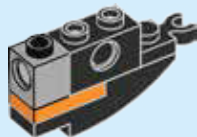

1x



1x

23

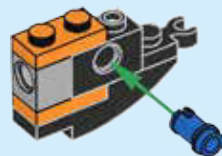

24

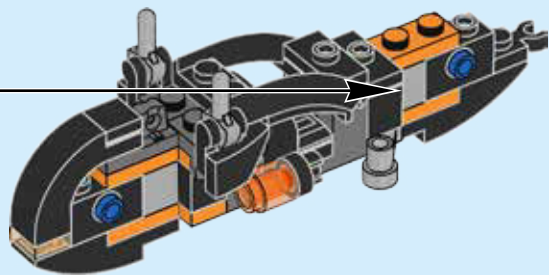

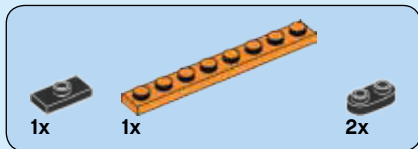

25

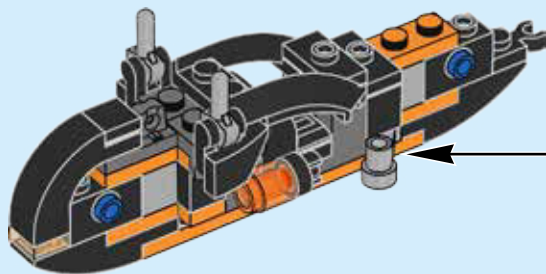
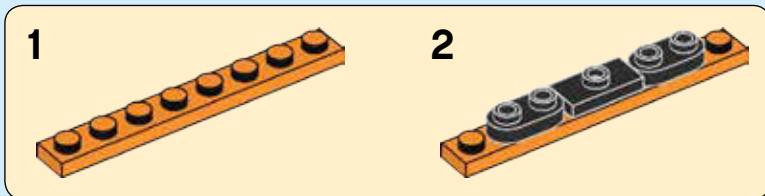



1x

26

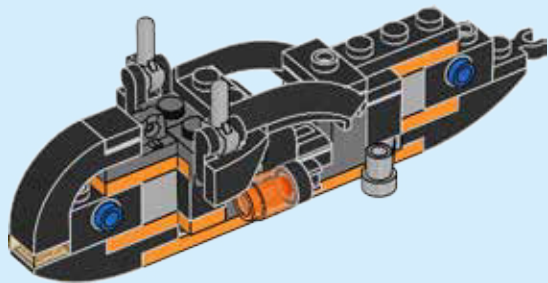

36



1x



1x

27

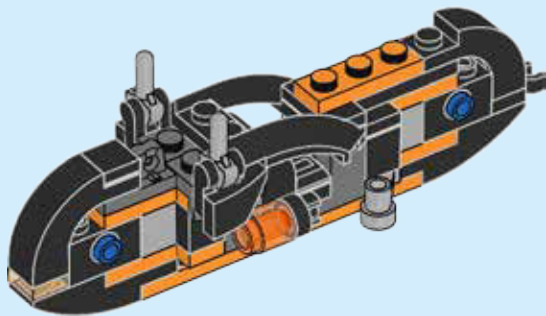



1x



1x

28

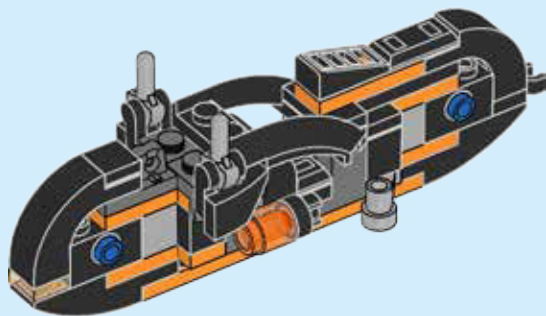

1x

29

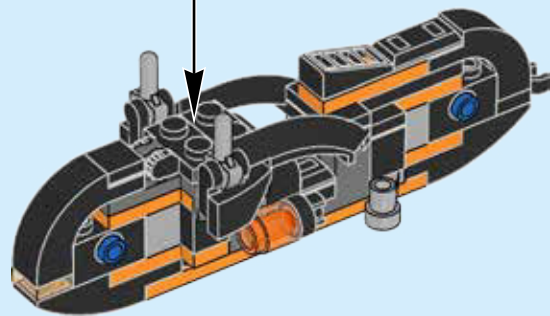



1x



1x

30

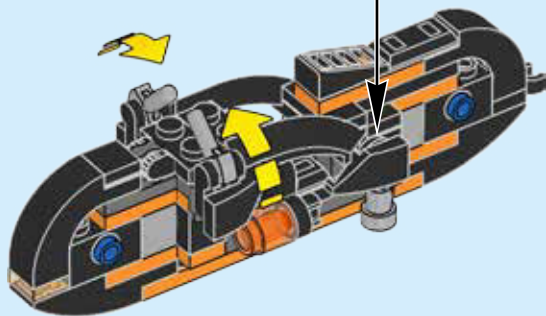
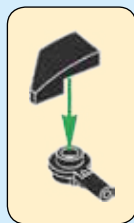



2x

2x

2x



2x



2x



2x

31

1

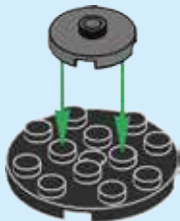

2

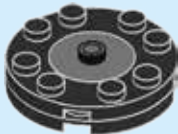

3



4

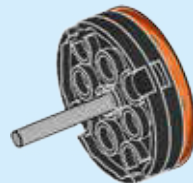

2x

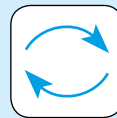

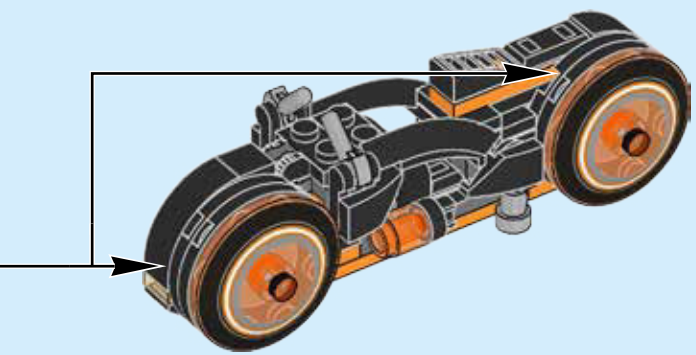

1x  1x 

32

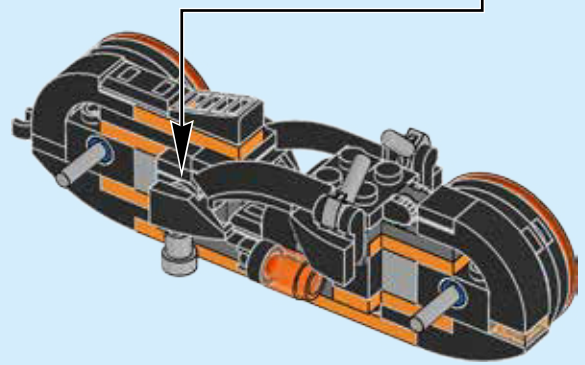
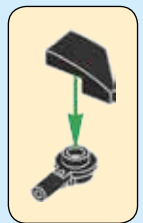
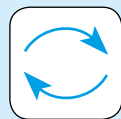

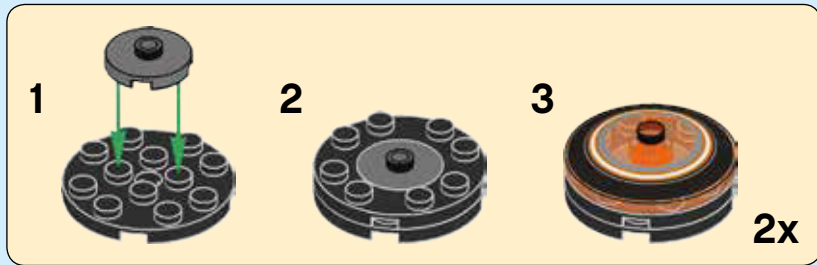
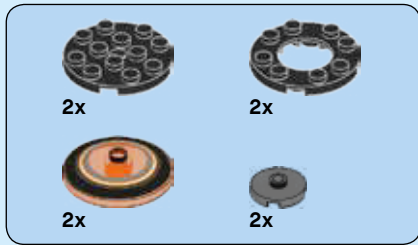

33

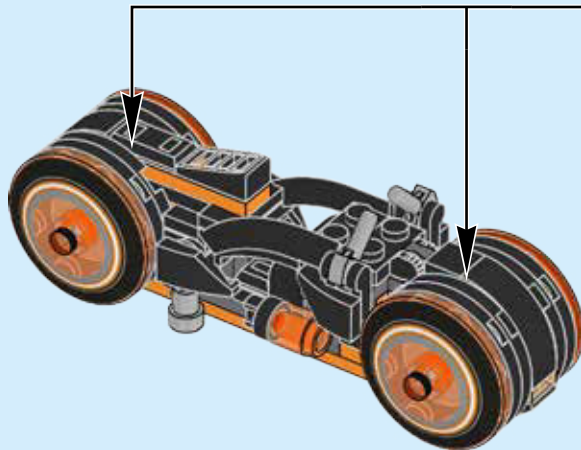

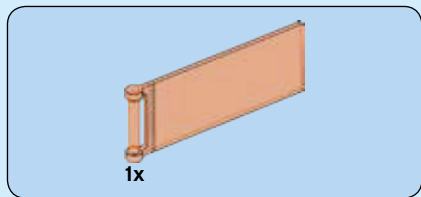

34

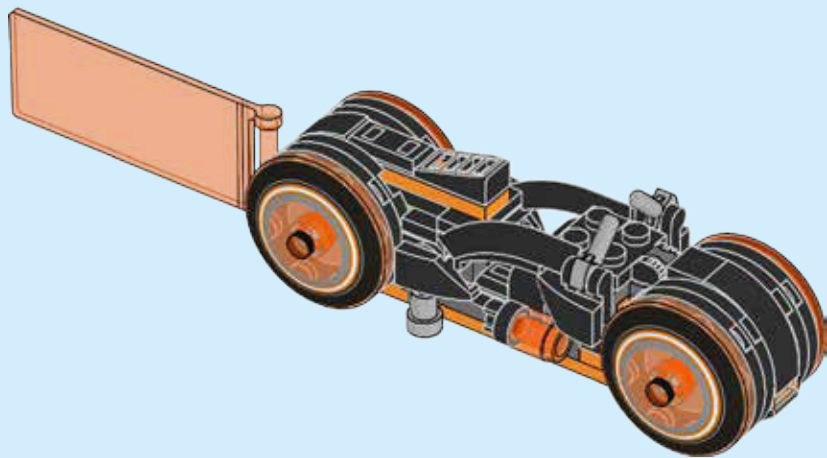

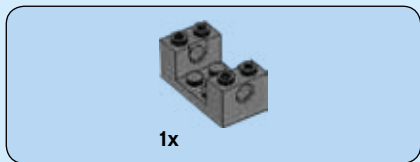
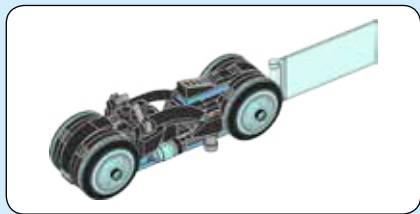

1

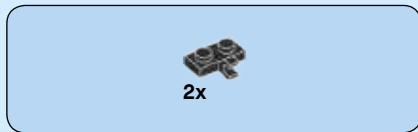
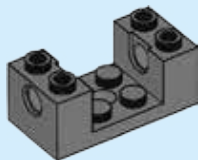

2

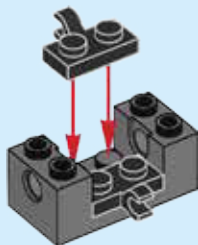



2x

3

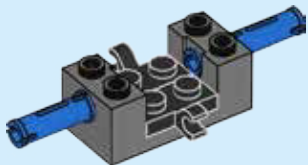

1x



2x

4

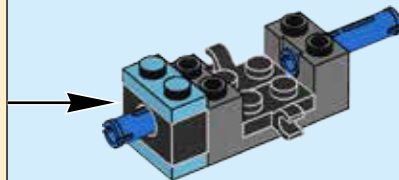
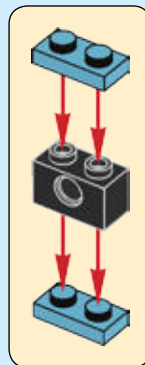

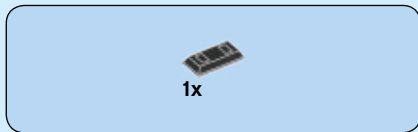

5

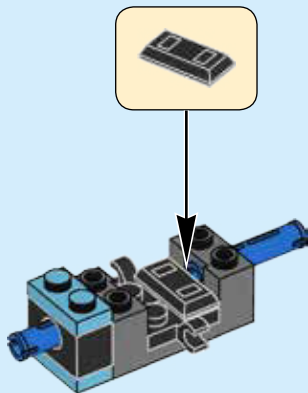

6

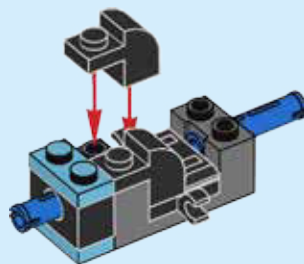



2x



2x

7

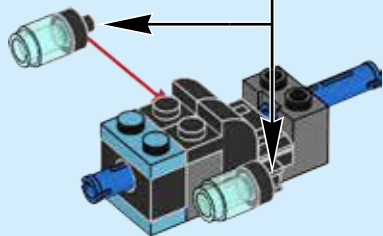
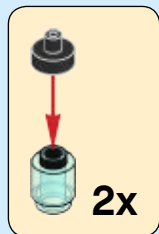

2x

8

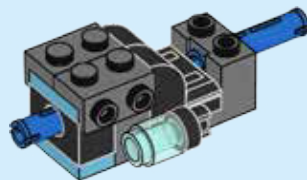

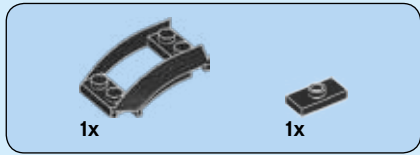

9

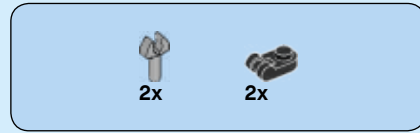
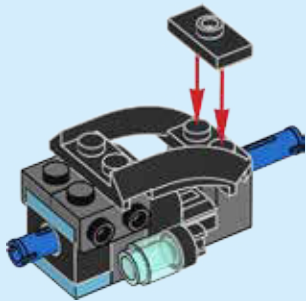

10

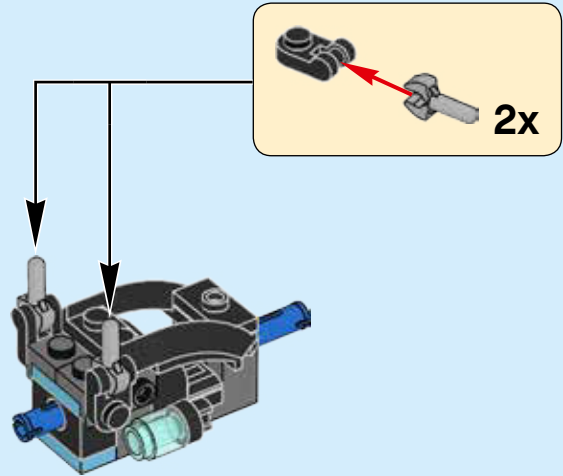



1x



1x

11

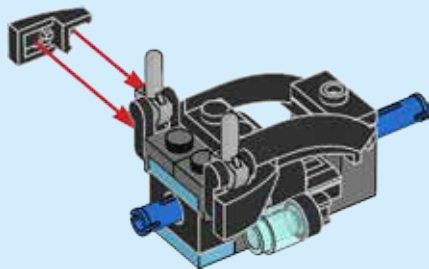



1x



1x

12

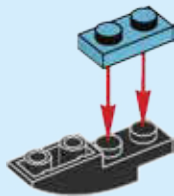

1x

13

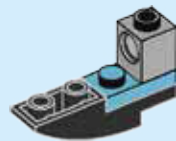



1x



1x

14



1x



1x

15

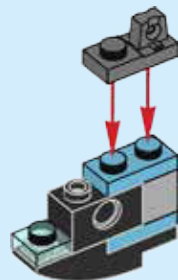



16

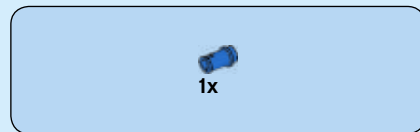
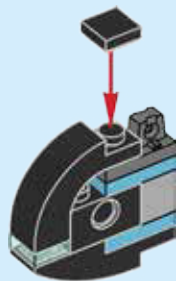

17

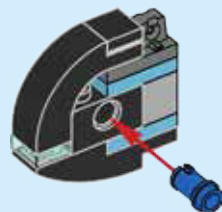

18

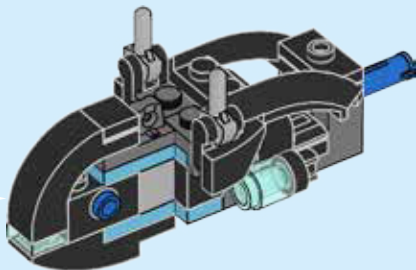

52

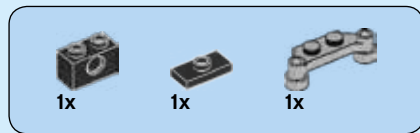

19

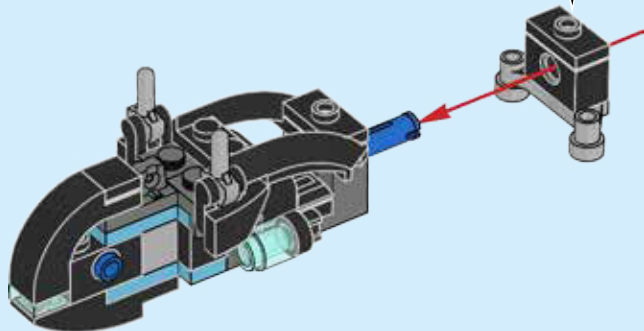
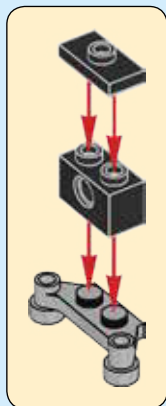



1x



1x

20

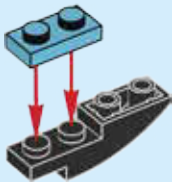

1x

21

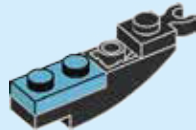



1x



1x

22



1x



1x

23

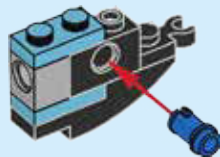

24

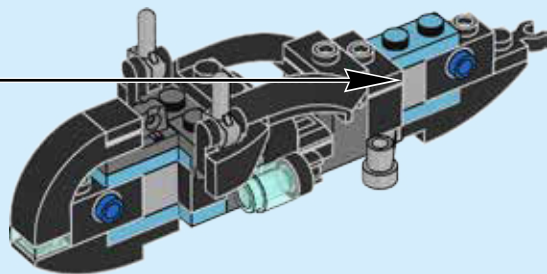

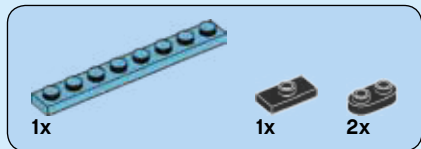

25

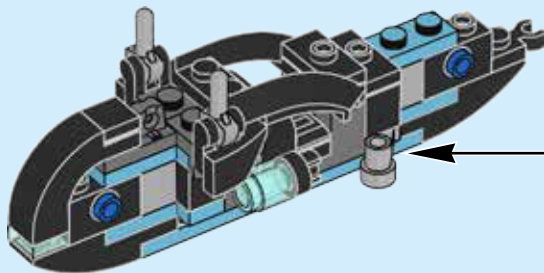
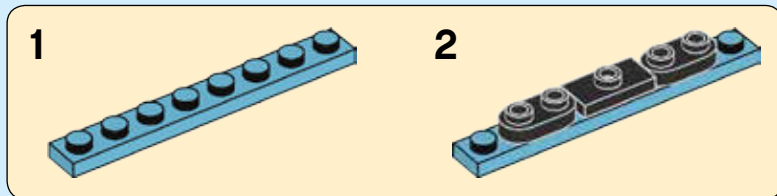



1x

26

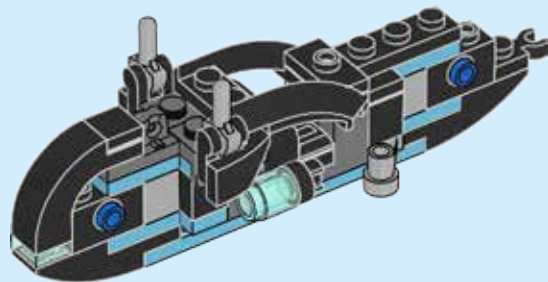

1x



1x

27

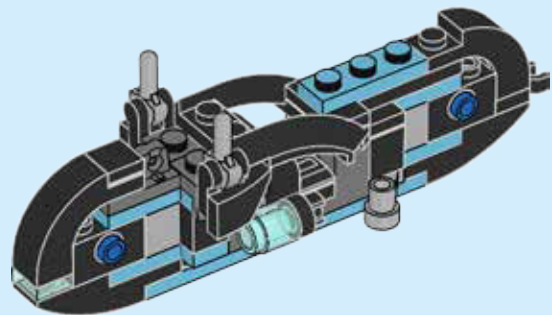



1x



1x

28

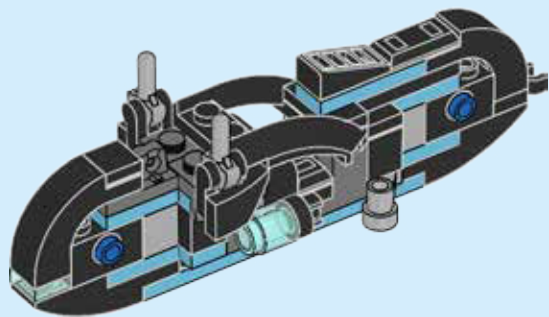

1x

29

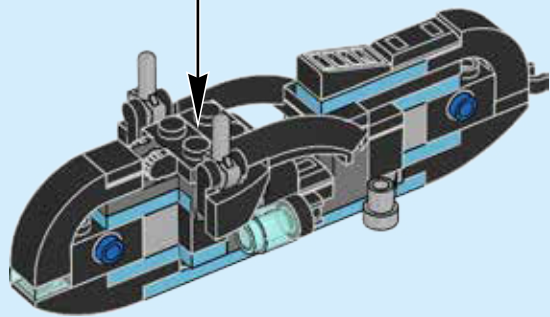



1x



1x

30

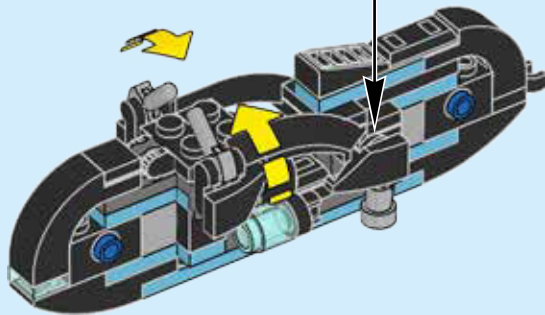
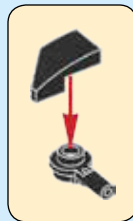



2x



2x



2x

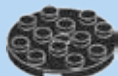

2x



2x



2x

31

1

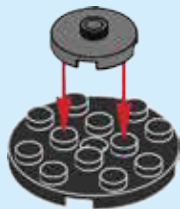

2

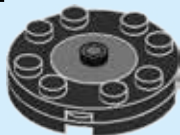

3

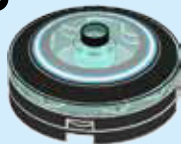

4

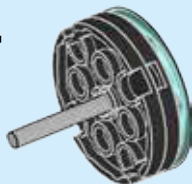

2x

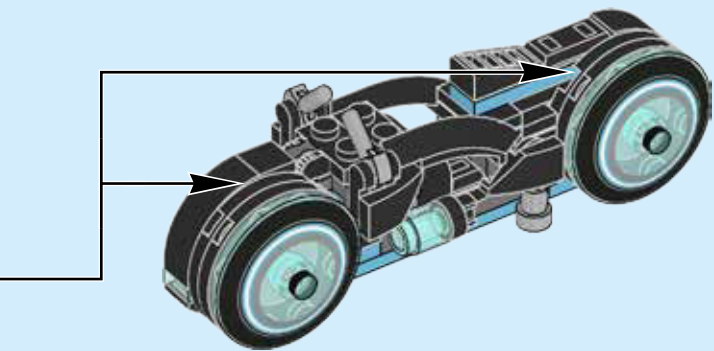

32

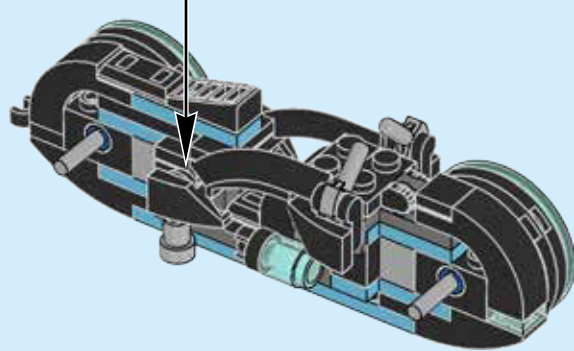
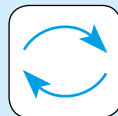

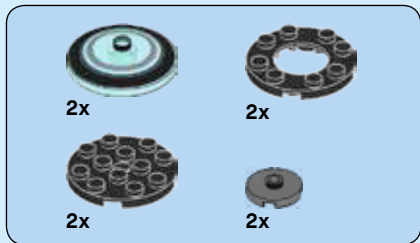

33

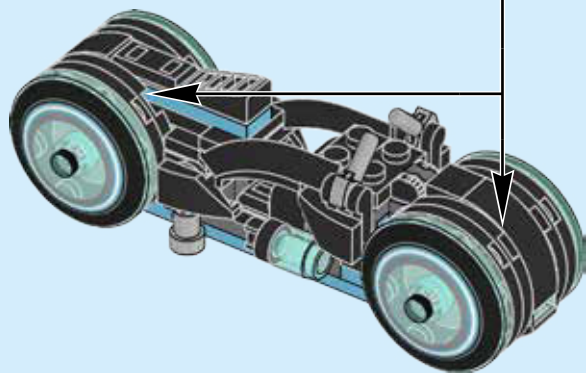

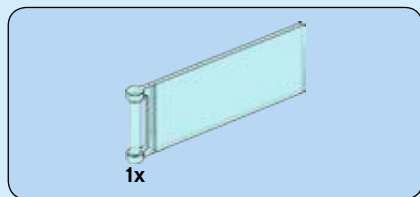

34

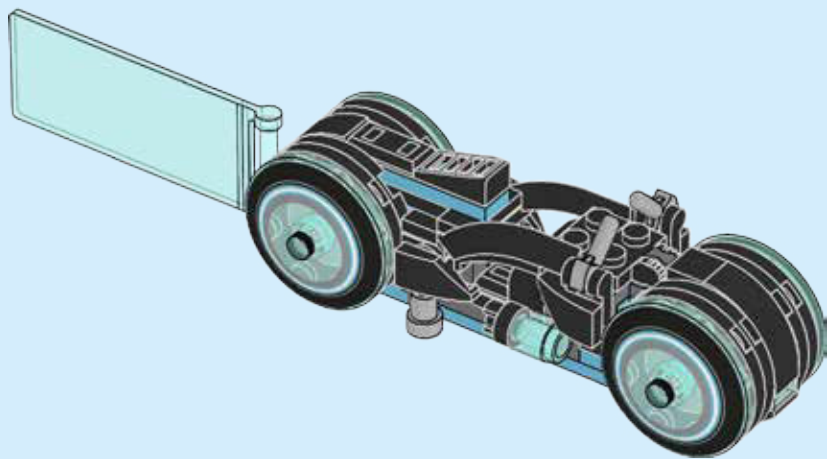

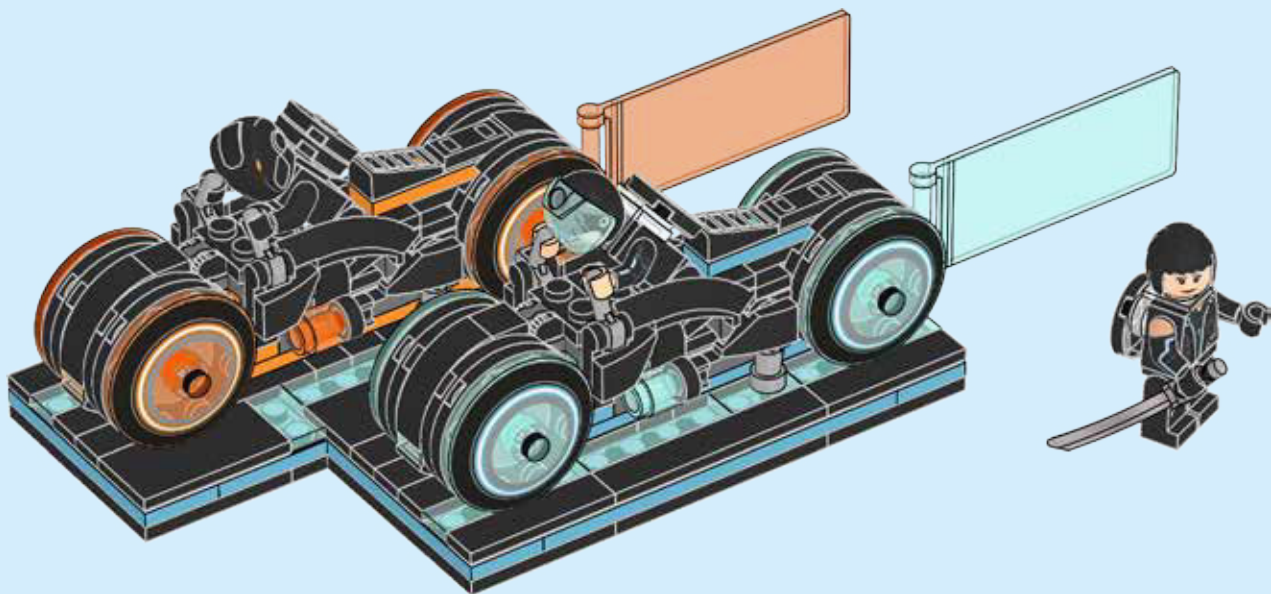

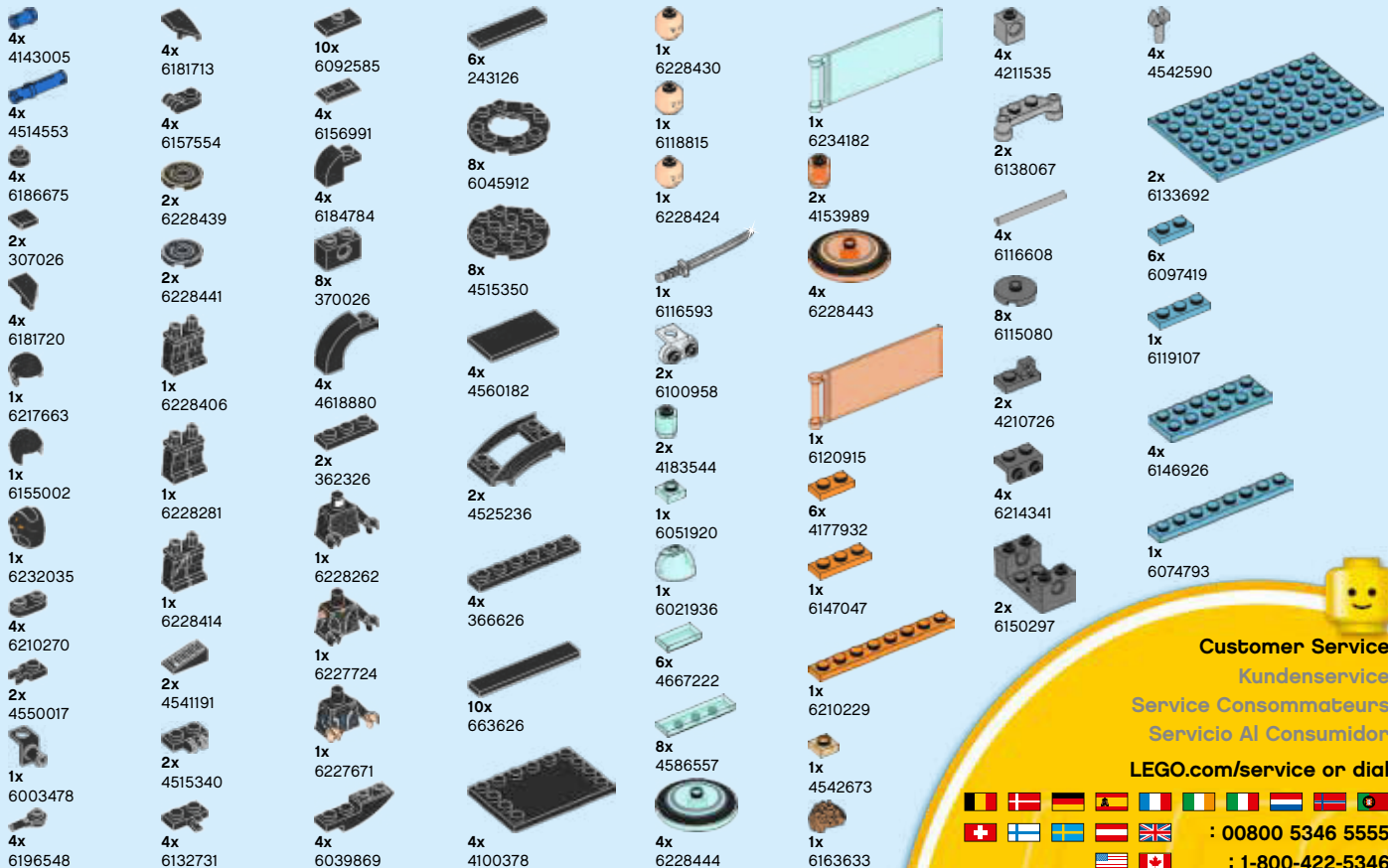

Customer Service

Kundenservice

Service Consommateurs

Servicio Al Consumidor

LEGO.com/service or dial



: 00800 5346 5555

: 1-800-422-5346

SHARE YOUR IDEA
TEILE DEINE IDEE
PARTAGE TON IDÉE
CONDIVIDI LA TUA IDEA
COMPARTE TU IDEA
PARTILHA A TUA IDEIA
TEDD KÖZZÉ AZ ÖTLETED
分享您的观点

LEGO® REVIEW
LEGO® PRÜFUNG
EXAMEN PAR LEGO®
REVIEW LEGO®
REVISIÓN DE LEGO®
AVALIAÇÃO LEGO®
LEGO® VÉLEMÉNYEZÉS
乐高®评论



GATHER SUPPORT
HOL' DIR UNTERSTÜTZUNG
RASSEMBLE DES VOTES
CHIEDI DI ESSERE SUPPORTATO
GANA APOYOS
OBTÉM APOIO
SZEREZZ TÁMOGATÁST
获得更多支持



NEW LEGO® PRODUCT
NEUES LEGO® PRODUKT
NOUVEAU PRODUIT LEGO®
NUOVO PRODOTTO LEGO®
NUEVO PRODUCTO LEGO®
NOVO PRODUTO LEGO®
ÚJ LEGO® TERMÉK
新的乐高® 产品



LEGO IDEAS



[LEGO.com/ideas](https://www.lego.com/ideas)

Do you like this LEGO® Ideas Set?

The LEGO Group would like your opinion on the new product you have just purchased. Your feedback will help shape the future development of this product series.

Please visit:

[LEGO.com/productsurvey](https://www.lego.com/productsurvey)

By completing our short feedback survey, you will be automatically entered into a drawing to win a LEGO® prize.

See website for official rules and details. Open to all countries where not prohibited.

